

archlit reserves the right to make changes without prior notice. (07.13.2020)

LeeSti Duet Double, extruded aluminum minimal design lighting fixture with remote drivers (max distance 80'). For Ceiling or Wall Adjustable, rotates in the longitudinal axis. Arms can have different lengths. Special blocking required for wall installations.

Direct and Indirect components on same axis, adjustable with light at opposite sides

Diffuser with film, even line of light (the dots generated by the LED source are not seen) and parabolic louver as options.

LeeDueDo

LeeSti Duet Double

Downlight Output

- 3017do - 3000 K 1200 lumens / ft 12 w /ft
 - 3014do - 3000 K 1000 lumens / ft 10 w /ft
 - 3011do - 3000 K 780 lumens / ft 7.5 w /ft
 - 3008do - 3000 K 560 lumens / ft 5.5w /ft
 - 3005do - 3000 K 350 lumens / ft 3.1 w /ft
 - 3517do - 3500 K 1200 lumens / ft 12 w /ft
 - 3514do - 3500 K 1000 lumens / ft 10 w /ft
 - 3511do - 3500 K 780 lumens / ft 7.5 w /ft
 - 3508do - 3500 K 560 lumens / ft 5.5w /ft
 - 3505do - 3500 K 350 lumens / ft 3.1 w /ft
 - WhTudo - White tuning 2700K @ 1050 lumens/foot and 6500k @1200 lumens/foot 12.5 watt/foot
- Use of programmable drivers allow different outputs (lumen output and load) in fix color temperature versions

Uplight Output

- 3017up - 3000 K 1200 lumens / ft 12 w /ft
 - 3014up - 3000 K 1000 lumens / ft 10 w /ft
 - 3011up - 3000 K 780 lumens / ft 7.5 w /ft
 - 3008up - 3000 K 560 lumens / ft 5.5w /ft
 - 3005up - 3000 K 350 lumens / ft 3.1 w /ft
 - 3517up - 3500 K 1200 lumens / ft 12 w /ft
 - 3514up - 3500 K 1000 lumens / ft 10 w /ft
 - 3511up - 3500 K 780 lumens / ft 7.5 w /ft
 - 3508up - 3500 K 560 lumens / ft 5.5w /ft
 - 3505up - 3500 K 350 lumens / ft 3.1 w /ft
 - WhTuUp - White tuning 2700K @ 1050 lumens/foot and 6500k @1200 lumens/foot 12.5 watt/foot
- All Uplight versions with light will have a transparent diffuser
Use of programmable drivers allow different outputs (lumen output and load) in fix color temperature versions

Mounting

- WA - Wall
- CE - Ceiling



LeeSti Duet Double

LeeSti / Wall/Ceiling

Finish

WH - White

BK - Black

CU - Custom Color

Specify RAL color

CU Ec - End caps Custom Color

Specify RAL color. difference in costs apply

End caps black unless specified.

Dimming

O - Non dimmable 120v

1 - Non dimmable 277v

4 - Dimmable 0-10v (4wires, 120 or 277 v)

Runs

A - 1' nominal 12 1/2"

B - 2' nominal 24 1/2"

C - 3' nominal 35"

D - 4' nominal 47"

E - 5' nominal 57 1/2"

F - 6' nominal 69 1/2"

G - 7' nominal 80"

H - 8' nominal 92"

Total Run: (0 ft 0 in)

Extrusions max length is 8' nominal

Product can be adjust from nominal sizes in multiples of 1.5".

Factory will produce submittals

Allow 1 1/2" between modules

archlit recommends 4' max for transport

Arms Length

A3 - 3"

A6 - 6"

A12 - 12"

A18 - 18"

A24 - 24"

A36 - 36"

Only ceiling mounted can be 36"

Canopy

RD - Round 4 1/4"

SQ - Square Plate 4 1/4" x 4 1/4"

Emergency

OO - No Emergency

EM - Emergency

Specify qty only if Emergency

Specify quantity of 4' nominal runs in runs

max for emergency battery is 4' nominal

Notes:

Drivers remote

Max distance to drivers 80'

McAdam 3

CRI greater 90

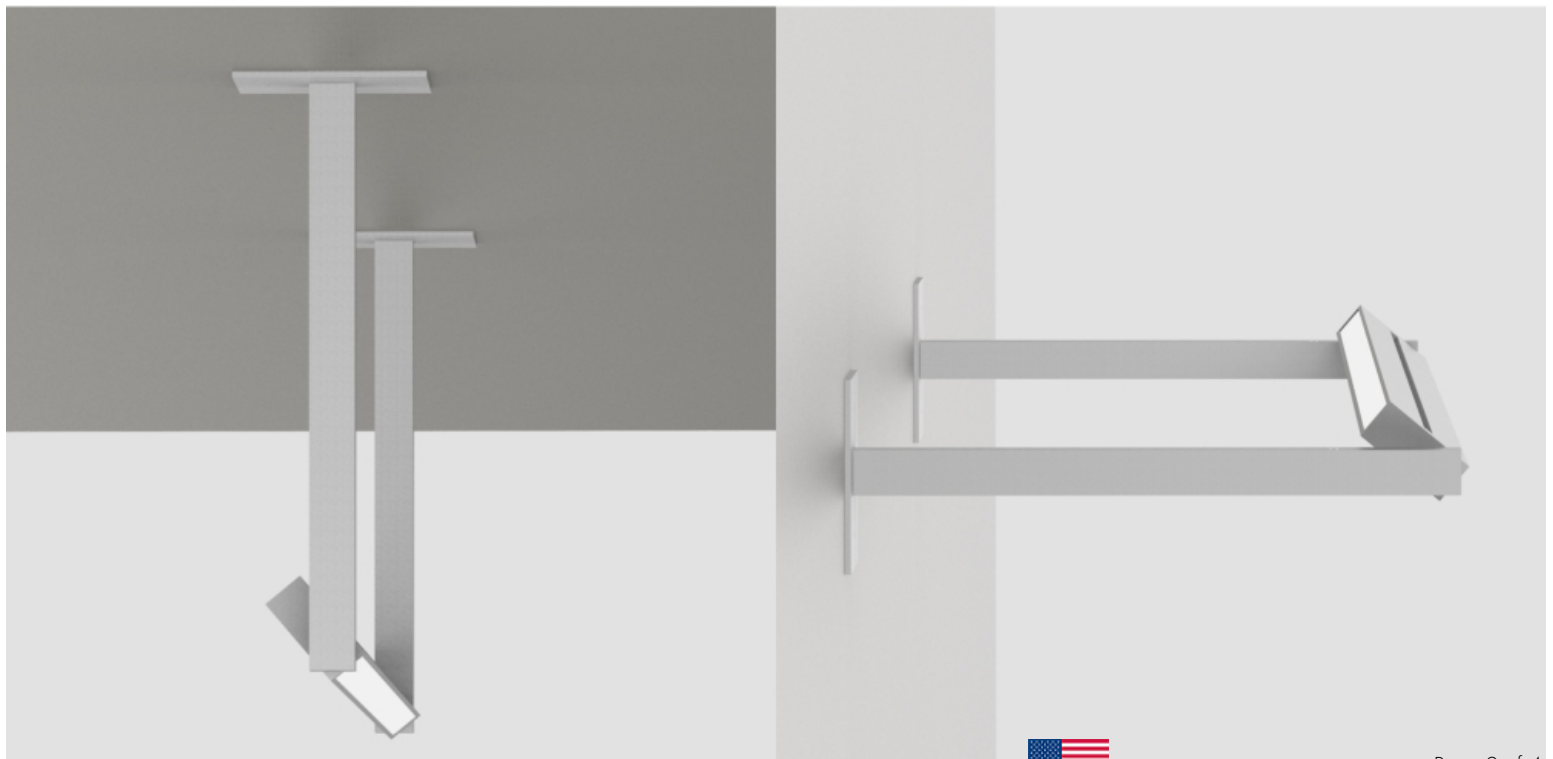

LeeSti Duet Double

LeeSti / Wall/Ceiling

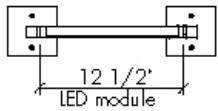
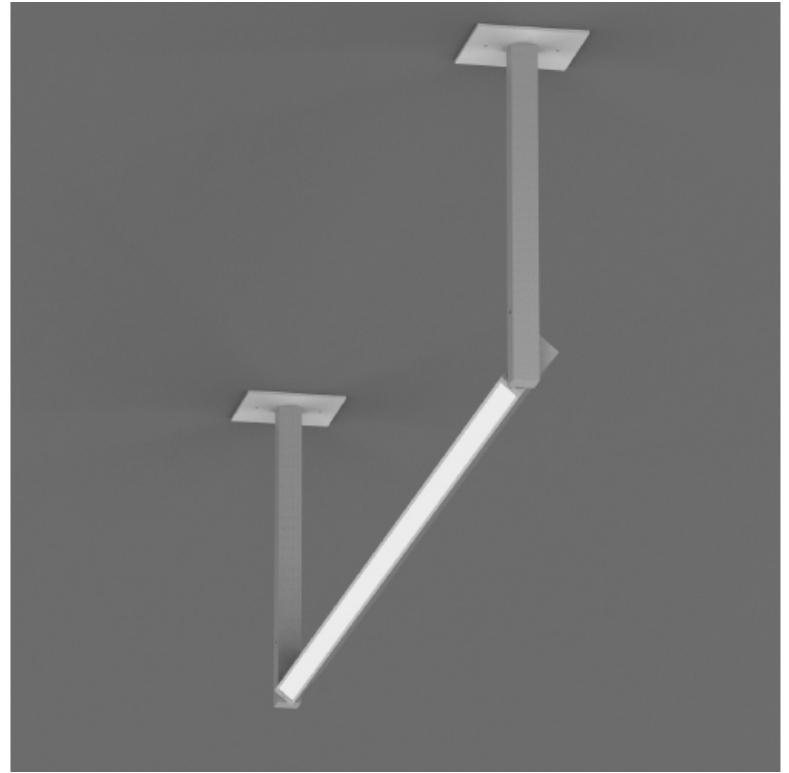
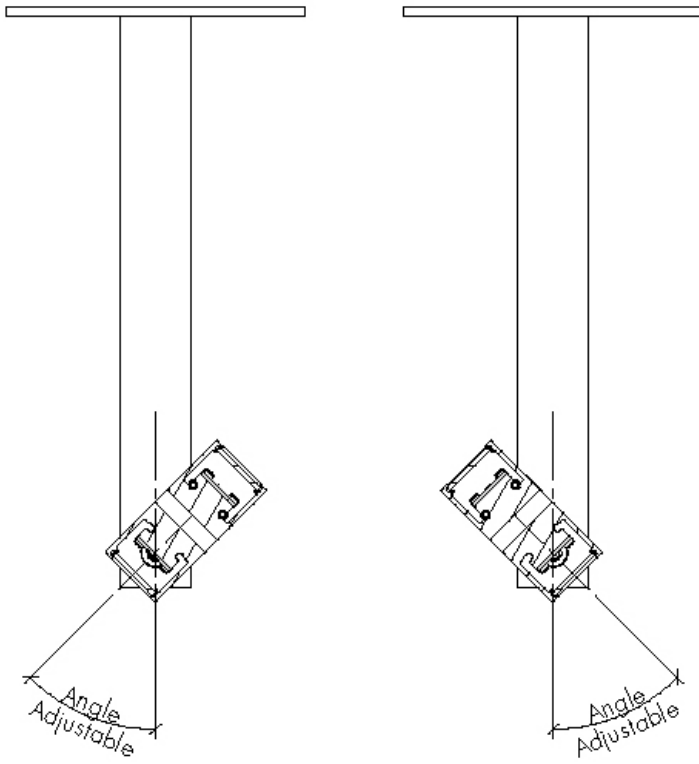

1' nominal

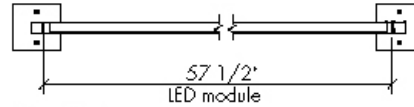

5' nominal

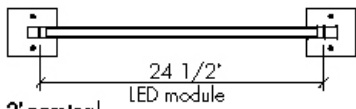

2' nominal

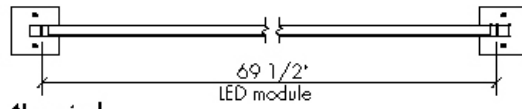

6' nominal

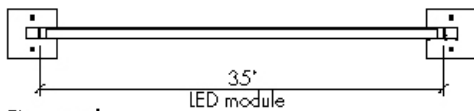

3' nominal

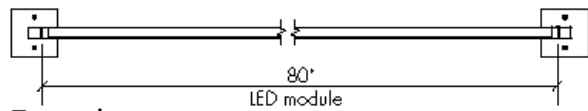

7' nominal

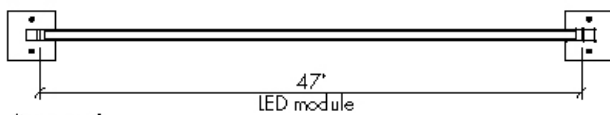

4' nominal

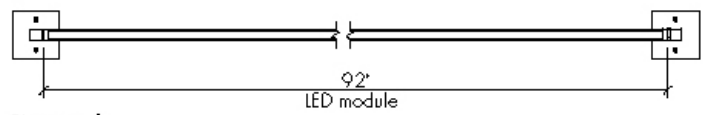

8' nominal



LeeSti Duet Double

LeeSti / Wall/Ceiling

archlit generates submittals for runs. size of boxes
TBD in documentation

